



LT-73X Ultra-low Turbidity Probe Operation Manual



April. 13, 2020

Rev. A

Pyxis Lab, Inc.

1729 Majestic Dr. Suite 5

Lafayette, CO 80026 USA

www.pyxis-lab.com

© 2017 Pyxis Lab, Inc.

Pyxis Lab Proprietary and Confidential

The information contained in this manual may be confidential and proprietary and is the property of Pyxis Lab, Inc. Information disclosed herein shall not be used to manufacture, construct, or otherwise reproduce the goods described. Information disclosed herein shall not be disclosed to others or made public in any manner without the express written consent of Pyxis Lab, Inc.

Limited Warranty

Pyxis Lab warrants its products for defects in materials and workmanship. Pyxis Lab will, at its option, repair or replace instrument components that prove to be defective with new or remanufactured components (i.e., equivalent to new). The warranty set forth is exclusive and no other warranty, whether written or oral, is expressed or implied.

Device Warranty Term

The Pyxis warranty term for the LT-73Xprobe is thirteen (13) months from original shipment from Pyxis. In no event shall the standard limited warranty coverage extend beyond thirteen (13) months from original shipment date.

Warranty Service

Damaged or dysfunctional instruments may be returned to Pyxis for repair or replacement. In some instances, replacement instruments may be available for short duration loan or lease.

Pyxis warrants that any labor services provided shall conform to the reasonable standards of technical competency and performance effective at the time of delivery. All service interventions are to be reviewed and authorized as correct and complete at the completion of the service by a customer representative or designate. Pyxis warrants these services for 30 days after the authorization and will correct any qualifying deficiency in labor provided that the labor service deficiency is exactly related to the originating event. No other remedy, other than the provision of labor services, may be APPLICABLE.

Repair components (parts and materials), but not consumables, provided in the course of a repair, or purchased individually, are warranted for 90 days ex-works for materials and workmanship. In no event will the incorporation of a warranted repair component into an instrument extend the whole instrument's warranty beyond its original term.

Warranty Shipping

A Repair Authorization Number (RA) must be obtained from Pyxis Technical Support before any product can be returned to the factory. Pyxis will pay freight charges to ship replacement or repaired products back to the customer. The customer shall pay freight charges for returning products to Pyxis. Any product returned to the factory without an RA number will be returned to the customer.

Pyxis Technical Support

Contact Pyxis Technical Support at service@pyxis-lab.com or 1-866-203-8397 (Mo-Fri 7:00AM-5PM MT)

Table of Contents

1	Introducing the Pyxis LT-73X Series	4
1.1	Features of the Pyxis LT-73X Series	4
1.2	Specifications	5
1.3	Unpacking the Pyxis LT-73X Series Probe	5
1.4	Standard Accessories	6
1.5	Optional Accessories.....	6
2	Installation	7
2.1	FR-100 Flow Reservoir Assembly for Drinking Water Installations	7
2.2	FT-100 In-Line Tee Assembly Installations.....	9
3	Quick 4-20mA Start.....	10
4	Calibration and Diagnosis.....	11
4.1	Calibration and Diagnosis by uPyxis Mobile APP	11
4.1.1	Calibration by uPyxis Mobile APP	13
4.1.2	4-20mA Span	17
4.1.3	Diagnosis	18
4.2	Calibration and Diagnosis by uPyxis Desktop APP	19
4.2.1	Calibration.....	21
4.2.2	4-20mA Span.....	24
4.2.3	Diagnosis	25
4.3	Calibration on the Controller	25
5	Modbus RTU.....	26
6	Probe Cleaning and Maintenance.....	26
6.1	Cleaning Procedure.....	26
6.2	Other Common Troubleshooting Issues	27

1 Introducing the Pyxis LT-73X Series

The **LT-73X Series** are proprietary inline turbidity sensors offered in a variety of ranges from 0.001 to 1,000 NTU with ultra-low resolution. Sensor format details are provided in the specification table of this document with options meeting ISO-7027 and EPA-180.1 compliance guidelines. Each of the LT-73X series sensors offer a unique flat surface distal end in a quartz glass plate, allowing for extended cleanliness and easy maintenance. These sensors are designed for optimal accuracy and performance in a wide range of turbidity water samples using 90° surface scatter configuration, offered in two flow assembly installation formats (FR-100 Flow Reservoir or FT-100 Inline Tee), making them highly versatile for a wide variety of drinking or industrial water applications. All LT-73X series sensors are offered in Warm White Light (LED) or InfraRed LED (860nm). They are powered by a 24 VDC/1.5W power supply and offer both 4-20 mA and RS-485 Modbus output signals. When clean, the unique Pyxis sensor design offers a calibration stability of <0.02NTU for up to 1-year of operation with no need for calibration. Additionally, these sensors can be wirelessly accessed via Bluetooth for Diagnostics, Cleaning & Calibration when using the **uPyxis APP** for mobile or desktop devices and the **MA-CR** Bluetooth Adapter.

1.1 Features of the Pyxis LT-73X Series

The LT-73X series include the following features:

- Model options available complying with ISO-7027 & EPA 180.1 standards
- Models offered in both Warm White Light (3200K) & InfraRed (860nm)
- All models offer LED light source for long operational life
- Resolution as low as 0.001 NTU options available
- FR-100 Flow Reservoir Assembly available for all LT-73X Series optimum resolution
- FT-100 In-Line Tee Assembly available for all LT-73X Series for industrial applications
- All models offer built-in transmitter, without preamplifier or meter head
- All models offer combination 4-20mA isolated signal and RS-485 Modbus output
- Simple / Wireless calibration using uPyxis Mobile or Desktop APPs and MA-CR Bluetooth Adapter
- All models are easily removed and cleaned without the need for tools
- All models offer a 4 second response time
- **Optional Ultra-Sonic Adapter for automatic cleaning (in development)**
- **Optional Solid-State Calibration Cap Kit (in development)**

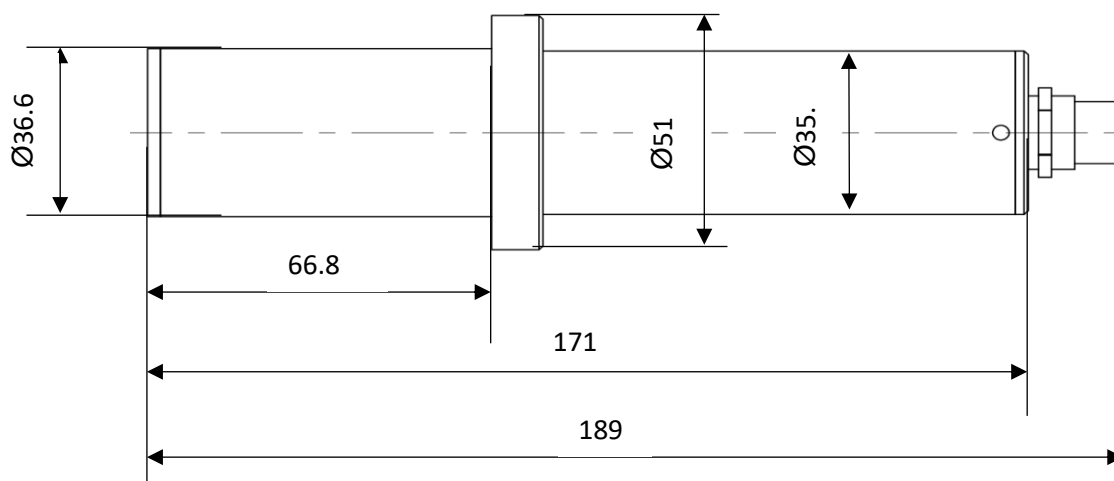

1.2 Specifications

Item	LT-736	LT-736B	LT-739	LT-739B	LT-737	LT-737B
P/N	53215	53223	53221	53225	53216	53224
Light Source (LED)	Warm White	860nm	Warm White	860nm	Warm White	860nm
Compliance	EPA180.1	ISO-7027	EPA180.1	ISO-7027	EPA180.1	ISO-7027
Range (NTU)	0.002 – 1000.00		0.002-40.00		0.001 – 5.000	
Accuracy Using FR-100	+/- 0.005 NTU or 2% <40NTU +/-0.02 NTU or 2% >40NTU		+/- 0.005 NTU or 2% <10NTU +/-0.01 NTU or 2% >10NTU		+/- 0.005 NTU or 1%	
Accuracy Using FT-100	+/- 0.01 NTU or 2% <40NTU +/-0.05 NTU or 2% >40NTU		+/- 0.01 NTU or 2% <10NTU +/-0.02 NTU or 2% >10NTU		+/- 0.01 NTU or 1%	
Repeatability Using FR-100	+/- 0.001 NTU or 0.5% <40NTU +/-0.02 NTU or 1% >40NTU		+/- 0.001 NTU or 0.5% <10NTU +/-0.01 NTU or 1% >10NTU		+/-0.001 NTU or +/-0.5%	
Repeatability Using FT-100	+/- 0.002 NTU or 1% <40NTU +/-0.05 NTU or 1% >40NTU		+/- 0.002 NTU or 1% <10NTU +/-0.02 NTU or 1% >10NTU		+/-0.002 NTU or +/-1%	
Calibration Stability	< 0.02 NTU/year drift (Assuming sensor is clean)		< 0.02 NTU/year drift (Assuming sensor is clean)		< 0.01 NTU/year drift (Assuming sensor is clean)	
Power Supply	22 – 26V DC, Power Consumption – 1.5W					
Outputs	Isolated 4 – 20 mA Analog Output & Isolated RS-485 Digital Output					
Wireless Access	Bluetooth Enabled with used w/ MA-CR or PowerPACK Adapters					
Installation	FR-100 Flow Reservoir Assembly / FT-100 In-Line Tee with 1.5” NPT Glue & Thread					
Weight	800 Gram (2.1 lbs – Sensor Only)					
Operational Pressure	LT-73X Series Sensors up to 100 psi (6.9 Bar) FR-100 Reservoir Atmospheric Pressure FT-100 Inline Tee up to 100 psi (6.9 Bar)					
Operating Sample Temperature	1-50°C (33.8 – 131°F)					
Sample Flow Rate	LT-73X Series Sensors = 0 – 40 L/min (0-10.6 GPM) FR-100 Flow Reservoir = 200 – 400mL/min FT-100 Inline Tee = 0 - 40 L/Min (0-10.6 GPM)					
Wet Material	LT-73X Series - 304 Stainless Steel / PVC & Polycarbonate					
Cable Length	Standard MA-4.9CR Cable (8Pin Adapters – 4.9ft) Flying Lead MA-1.5CR Cable (8 Pin Adapter / Flying Leads – 1.5ft) <i>Extension Cables Available</i>					
Calibration	Pyxis Formazin Standards & Dry Secondary Zero Standard for Field Cal = 0.01 Repeatability Pyxis Solid State Calibration Kit Pyxis Lab Factory Ultra-Pure Calibration Services = 0.001 Repeatability					
Rating	IP67 (sensor)					
Regulation	CE Marked					
Dimension	189mm (7.4inch) Length x 36mm (1.44inch) Body Diameter					

1.3 Unpacking the Pyxis LT-73X Series Probe

Remove the instrument and accessories from the shipping container and inspect each item for any damage that may have occurred during shipping. Verify that all items listed on the packing slip are included. If any items are missing or damaged, please contact Pyxis Customer Service at service@pyxis-lab.com

1.4 Standard Accessories

The following accessories are included in the LT-73Xprobe package (as shown in Figure 1):

- One LT-73X Series Ultra-low Turbidity probe
- One MA.4.9CR – (Standard Cable w/2x 8Pin Adapters – 4.9ft)
- One MA-1.5CR – (Flying Lead Cable w/8Pin Adapter – 1.5ft)
- The full instrument manual is available for download at www.pyxis-lab.com/support.html



Figure 1 LT-73X Series Ultra-low Turbidity Probe

1.5 Optional Accessories

The following optional accessories can be ordered from Pyxis Customer Service, order@pyxis-lab.com or Pyxis EStore at www.pyxis-lab.com/shop

Accessory Name	Item number
FR-100 Flow Reservoir Assembly (Drinking Water Required for LT-73X)	50779
FT-100 In-Line Tee Assembly (Pressurized In-Line Flow Tee for LT-73X)	50780
MA-CR Bluetooth Adapter (For use with Pyxis 8Pin Sensors)	MA-CR
MA-NEB (USB Bluetooth Adapter for use with Laptop or Desktop)	MA-NEB
MA-50CR Extension Cable-50 feet	50743
MA-100CR Extension Cable-100 feet	50744



2 Installation

2.1 FR-100 Flow Reservoir Assembly for Drinking Water Installations

For use in drinking water installations, the LT-73X ultra-low turbidity sensors should be installed using the Pyxis FR-100 flow reservoir assembly. This uniquely designed reservoir operates in a by-pass format at a 200-400mL/min flow rate and serves as a calming vessel prior to the sensors measurement of ultra-low or ultra-pure turbidity. Specifically designed to reduce stray light interference, the FR-100 reservoir assembly also allows for the elimination of air bubble entrainment, drop-out of large particulate and suspended solids including precipitated inorganics such as iron and manganese. The FR-100 flow reservoir assembly comes wall or panel mountable and complete including ¼ " tubing inlet with isolation valve, pressure reducing valve, in-line flow meter, ⅜ " tubing sample output and overflow assembly as well as ½" NTP bottom blowdown ball valve for solids removal. The LT-73X Series sensors easily install via the union adapter provided on the side wall of the FR-100 flow reservoir for simple removal and maintenance. When emptied and cleaned, the FR-100 may also serve as a zero-point calibration of the sensor. Replacement sensors or reservoirs may be purchased independently and as desired.

NOTE Pyxis Lab is actively developing an Ultra-Sonic Cleaning Assembly to be used in the FR-100 flow reservoir assembly. This device will be offered as an optional accessory for use with the FR-100 flow reservoir, enabling an automatic ultra-sonic cleaning of the LT-73X Series sensors enabling extended operation without the need for probe removal and cleaning. Pyxis Lab will amend this manual once this new product accessory is available for purchase.



Figure 2 FR-100 Flow Reservoir Assembly

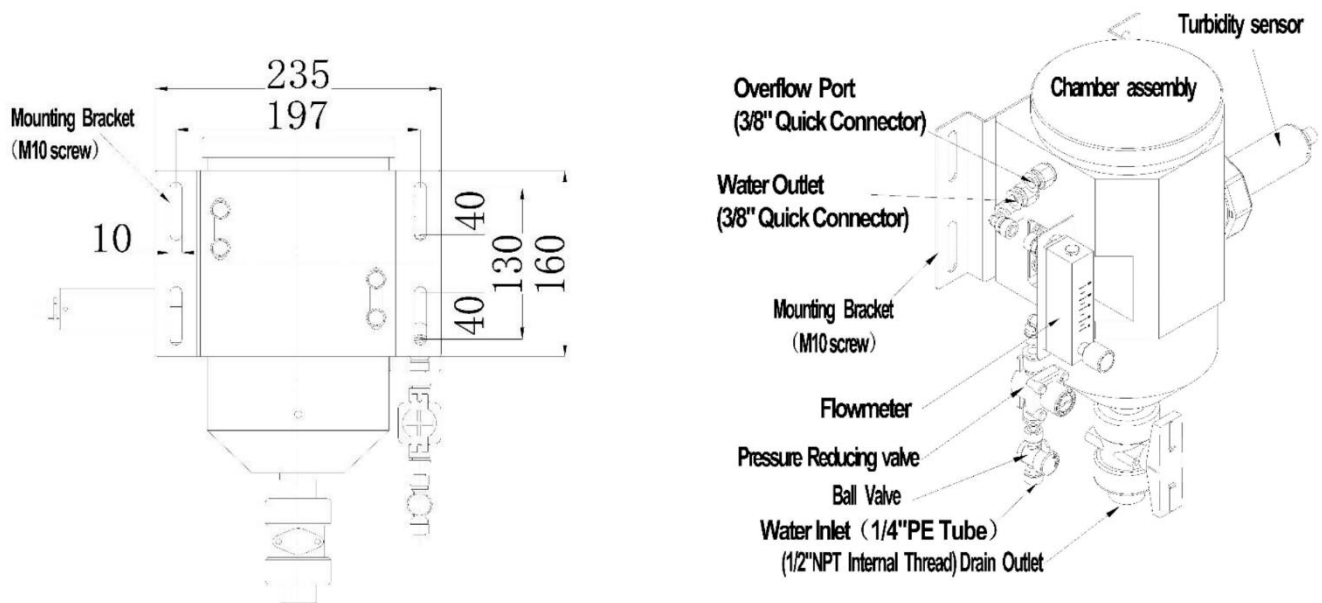

Figure 3 FR-100 Flow Reservoir Assembly Dimensions (mm) & Diagram

2.2 FT-100 In-Line Tee Assembly Installations

For use in alternative installations, the LT-73X ultra-low turbidity sensors may also be installed using the Pyxis FT-100 in-line flow Tee assembly. This uniquely designed in-line Tee operates at up to 40 Liters/min (10.6 GPM) flow rate and operating pressures as high as 6.9 bar (100psi). Constructed of Schedule 40-CPVC and designed with a unique 45° downward angle for extended sensor cleanliness, the FT-100 in-line Tee assembly allows for users to install the LT-73X Series in pressurized flow applications with limited footprint. This in-line Tee dramatically reduces the installation space requirement and is highly compatible with most by-pass sensor plumbing installations allowing the user to easily remove the sensor for wireless cleaning and maintenance. Zero-point calibration may be conducted on the LT-73X series sensors using a properly cleaned FT-100 inline Tee, via the uPyxis APP. The FT-100 inline-Tee assembly offers 1.5" FNPT and 1.5" FNPT Socket Adapters with quick unions to allow for rapid installation or replacement. The FT-100 inline-Tee assembly may be purchased independently as desired and as shown in Figure 4.



Figure 4 FT-100 In-Line Tee Assembly Installations

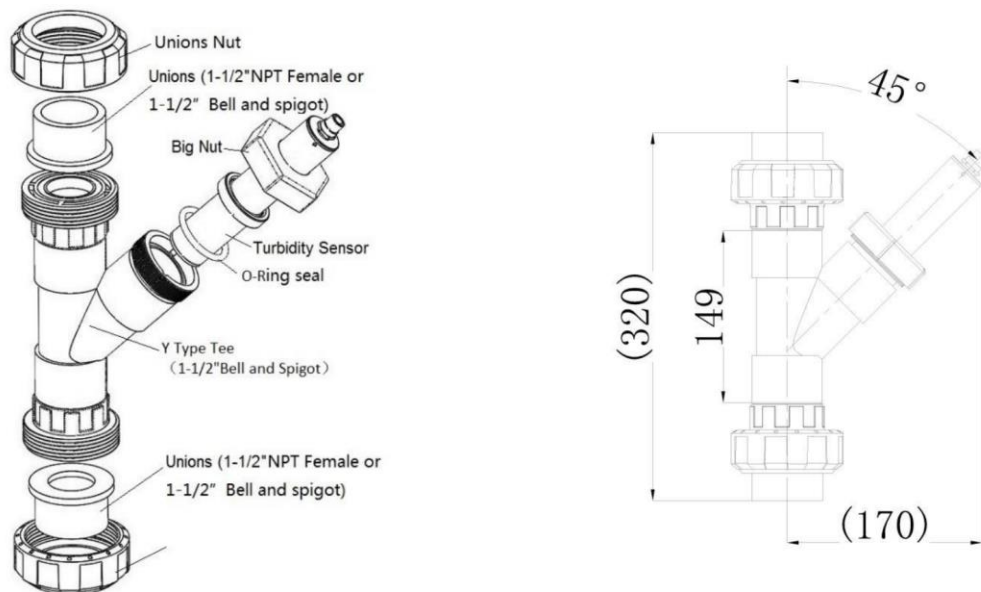

Figure 5 FT-100 In-Line Tee Assembly Dimensions (mm) & Diagram

3 Quick 4-20mA Start

Follow the wiring table below to connect the LT-73Xprobe to a controller.

Color	Designation
Red	24V
Brown	Power GND-
Grey	Not Connected
White	4-20mA +
Pink	4-20mA - <i>(Internally connected to power ground)</i>
Blue	RS-485 A
Yellow	RS-485 B
Green	Analog Ground

NOTE The 24V power ground and the 4-20 mA- return are internally connected.

If the 24V power ground and the 4-20 mA return in the controller are internally connected (non-isolated 4-20mA input), it is unnecessary to connect the 4-20 mA- (blue pink wire) to the 4-20 mA negative terminal in the controller. If a separate DC power supplier other than that from the controller is used, make sure that the output from the power supply is rated for 22-26 VDC @ 65mA.

Detailed wiring diagrams for common controllers are available from www.pyxis-lab.com.

4 Calibration and Diagnosis

The LT-73X ultra-low turbidity probe is rigorously calibrated before leaving the factory. As such, users do not need to calibrate the probe for a period of one year if the sensor is maintained clean. Users can however calibrate the probe according to their needs and as desired using the MA-CR Bluetooth adapter and uPyxis APP for mobile or desktop devices.

When the LT-73X probe is connected via Bluetooth to the uPyxis APP, users may perform a **Diagnostic Check** of the probe which will determine if the probe needs to be calibrated. To complete this task, the user must DRAIN the FR-100 flow reservoir or FT-100 tee. Then CLEAN by wiping the FR-100 flow reservoir or FT-100 tee wall and probe surface with a dust-free cloth or paper towel. Confirm that there are no obvious contaminants on the vessel walls and probe surface. Once properly drained and cleaned, re-insert the LT-73X series probe into the FR-100 or FT-100, depending on which installation format is in use. While connected to the uPyxis APP, read the displayed value of the connected probe. The following requirements dictate if a formal Calibration is required.

- 1) If the uPyxis displayed reading of LT-73X probe is less than 0.1NTU then no calibration is required. You may re-start the probe with no calibration.
- 2) If the uPyxis displayed reading of the LT-73X probe is greater than 0.1NTU, please proceed to formal calibration as specified in this manual.

4.1 Calibration and Diagnosis by uPyxis Mobile APP

Connect and power the LT-73X probe using the Pyxis Bluetooth adapter (P/N: MA-CR) as shown in the following connection diagram (Figure 6). The power should be sourced from a 24 VDC power terminal of a controller. If a controller is not available, please purchase a 24 V power supply that can directly connect to the LT-73X probes with proper cable connectors from Pyxis.

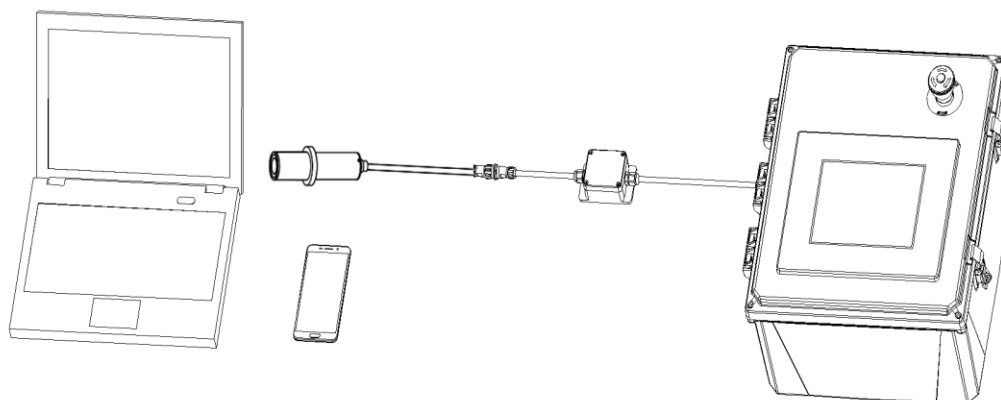

Figure 6 LT-73X and MA-CR Bluetooth Adapter Powered By Connected Controller



Download and install the uPyxis APP from Apple iStore or Google Play. Turn on Bluetooth in the mobile device (please do not pair the device Bluetooth to any Pyxis device, the uPyxis APP will do the pairing). Open the uPyxis APP in the mobile device. Swipe down to refresh the phone screen to scan the available Pyxis Bluetooth devices. The discovered devices will be listed (Figure 7).

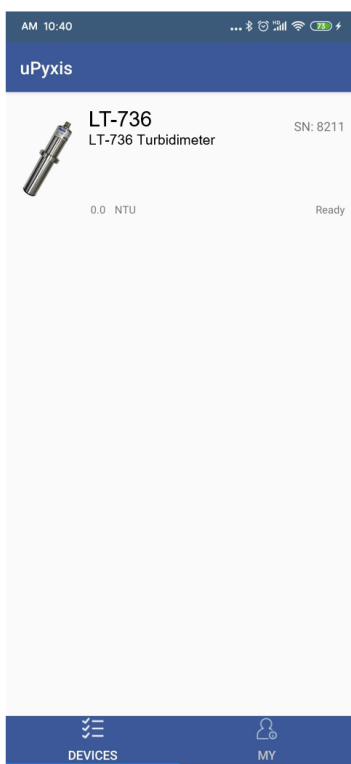

Figure 7

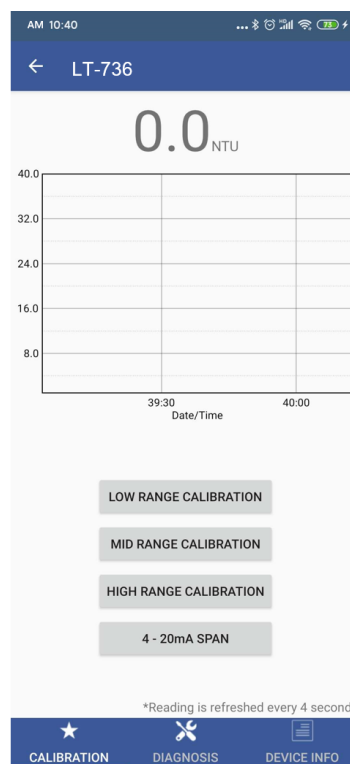

Figure 8

Tap the discovered LT-73X series probe to connect to it via Bluetooth. The uPyxis APP can identify the probe type if multiple Pyxis probes are discovered in the scan. For legacy generation Pyxis probes, a dialog message window will be displayed to ask the user to select a probe type. In this case, please select LT-736 or LT-737.

As shown in Figure 8, when connected via the MA-CR Bluetooth adapter, the uPyxis calibration page will display the current turbidity value being measured by the LT-73X series sensor connected. Four functional tabs are available in this page: Low-Range Calibration, Mid-Range Calibration, High-Range Calibration and 4-20mA Span.

4.1.1 Calibration by uPyxis Mobile APP

Low-Range Calibration Process - Empty the FR-100 flow reservoir or FT-100 tee, wipe the flow reservoir wall and probe surface with a dust-free cloth or dust-free paper towel, and confirm that there are no obvious contaminants on the reservoir wall and probe surface. Fill the FR-100 flow reservoir or FT-100 tee with DI (Deionized water), then use the brush or the dust-free cloth to clean the FR-100 flow reservoir or FT-100 tee wall and the probe surface, then thoroughly drain the polluted DI water. Repeat the cleaning operation three times to ensure optimum cleanliness. Then fill the FR-100 flow reservoir or FT-100 tee with bubble-free deionized water, after the displayed data is stable, click "Low Range Calibration" to perform low range calibration (Figure 9), turbidity value, enter "0"; as shown in Figure 10, if the calibration is successful, the interface will return a message "Calibration Succeeded". If the calibration has failed, the interface will return a message "Calibration Failed", as shown in Figure 12.

Optional Secondary Standard Using Reservoir or Tee - User also may use the empty FR-100 flow reservoir or FT-100 tee as the secondary standard to calibrate the turbidity probe in the Low-Range Calibration step. To do this, empty the FR-100 flow reservoir or FT-100 tee, wipe the flow reservoir walls and probe surface with a dust-free cloth or dust-free paper towel, and confirm that there are no obvious contaminants on the reservoir walls and probe surface, after the displayed data is stable, click "Low Range Calibration" to perform low range calibration (Figure 9), turbidity value, enter "0.1"; as shown in Figure 10, if the calibration is successful, the interface will return a message "Calibration Succeeded" as shown in Figure 11. If the calibration has failed, the interface will return a message "Calibration Failed", as shown in Figure 12.

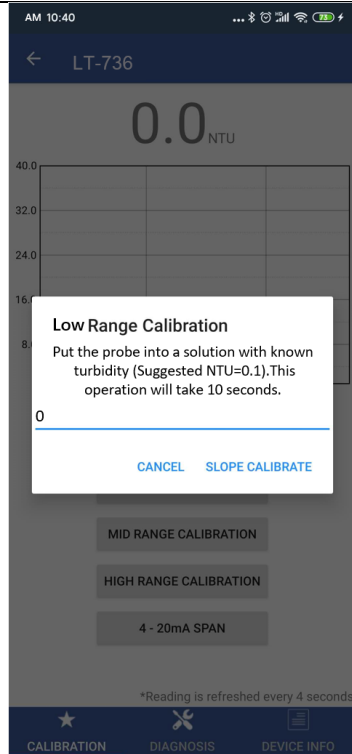

Figure 8

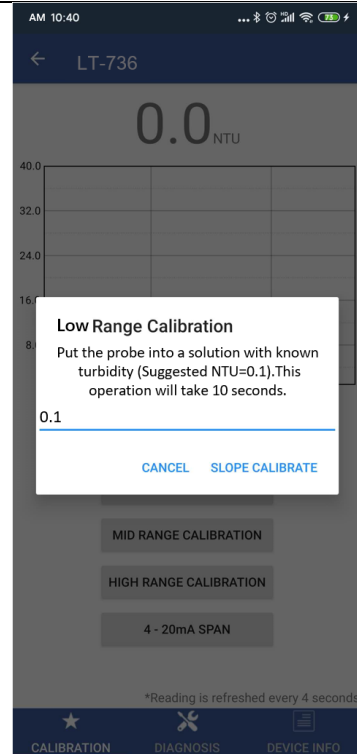

Figure 9

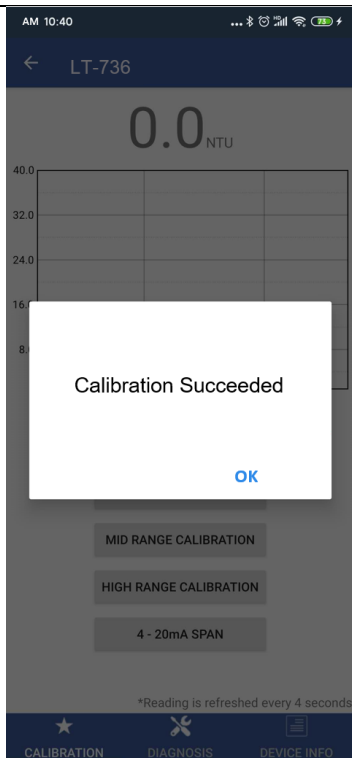

Figure 10

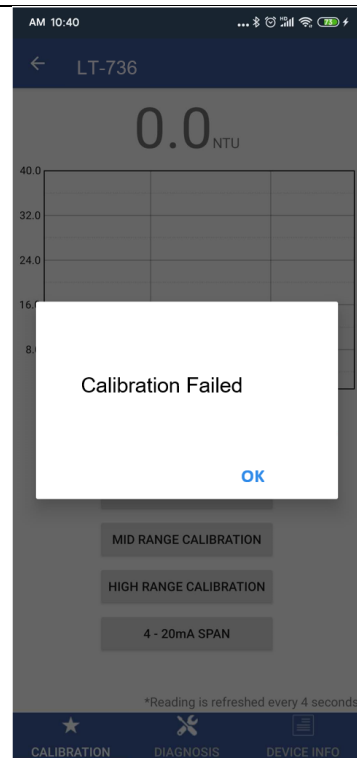

Figure 11

Mid-Range Calibration Process – After conducting the Low-Range Calibration steps, refill the FR-100 flow reservoir or FT-100 tee with a known turbidity standard solution (***NOTE*** The recommended turbidity mid-range calibration turbidity standard solution for LT-736 is not less than 5NTU and not more than 10 NTU. The recommended turbidity mid-range calibration turbidity standard solution for LT-737 is not less than 0.5NTU and not more than 2 NTU), after the displayed data is stable, click "Mid-Range Calibration" to perform middle range calibration, enter the known turbidity value in the dialog window as in figure 13, if the calibration is successful, the interface will return a message "Calibration Succeeded". If the calibration has failed, the interface will return a message "Calibration Failed".

High-Range Calibration Process - If the high range calibration is not required, the user does not need to calibrate the high range. To continue the high range calibration using the second turbidity standard solution. Discharge the first turbidity standard solution, fill the FR-100 flow reservoir or FT-100 tee with a known turbidity standard solution. (***NOTE*** The recommended turbidity high-range calibration turbidity standard solution for LT-736 is not less than 500NTU and not more than 1000 NTU. The recommended turbidity high-range calibration turbidity standard solution for LT-737 is not less than 2.0NTU and not more than 5 NTU), after the displayed data is stable, click "High-Range Calibration" to perform high range calibration, enter the turbidity value in the dialog window as in figure 14. If the calibration is successful, the interface will return a message "Calibration Succeeded". If the calibration has failed, the interface will return a message "Calibration Failed".

Trouble Shooting Steps for Failed Calibration Messages

- The Deionized water has not been contaminated.
- The standard solution is not expired or has not been contaminated.
- The probe is clean and not contaminated with debris or other materials.
- The FR-100 flow reservoir or FT-100 tee is not blocked with debris or other materials.

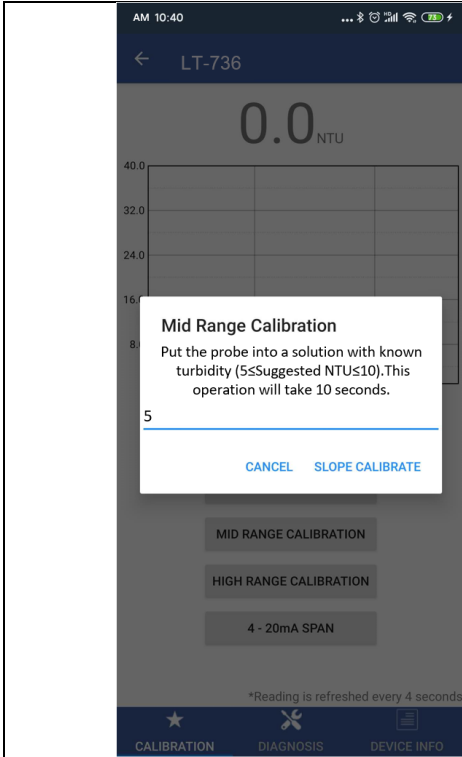

Figure 12

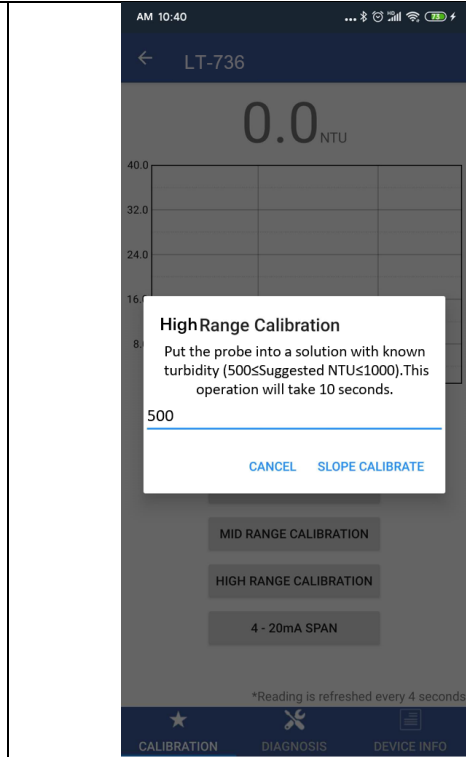

Figure 13

○

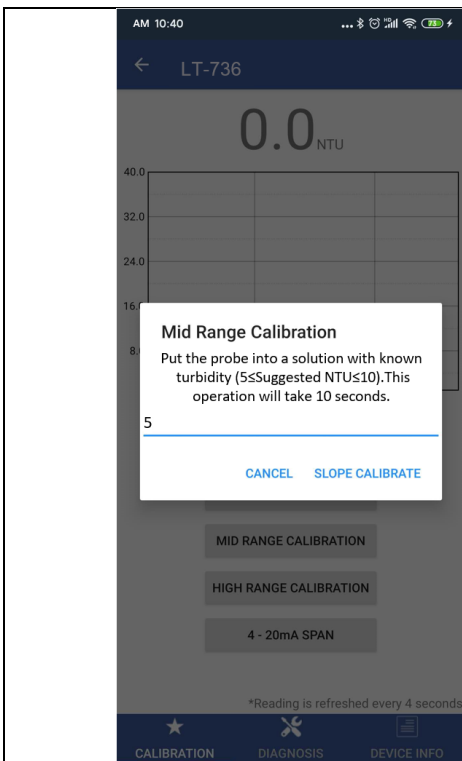

Figure 14

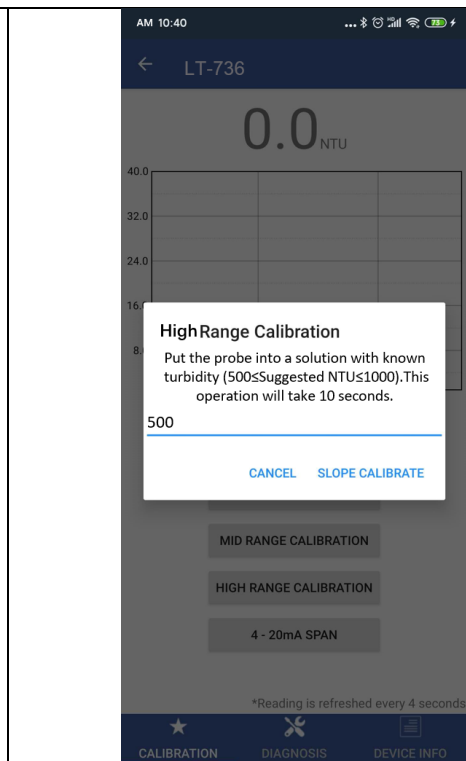

Figure 15

4.1.2 4-20mA Span

The default 4-20mA span is 20 mA = Maximum NTU Value of Sensor Range and 4 mA = 0 NTU in water. Tap 4-20mA Span to change the turbidity in water value corresponding to the output (Figure 15). ***NOTE*** The 4-20mA Span feature allows users to REDUCE the upper 20mA output scale only. You cannot INCREASE the upper limit of the sensor.

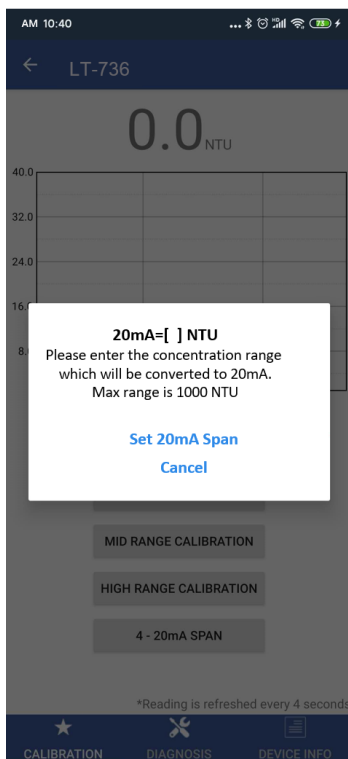

Figure 16 Enter Desired Lower Upper Limit Assign New 20mA Value

4.1.3 Diagnosis

Tap Diagnosis in the bottom of the APP page to launch the diagnosis page (Figures 16 and 17).

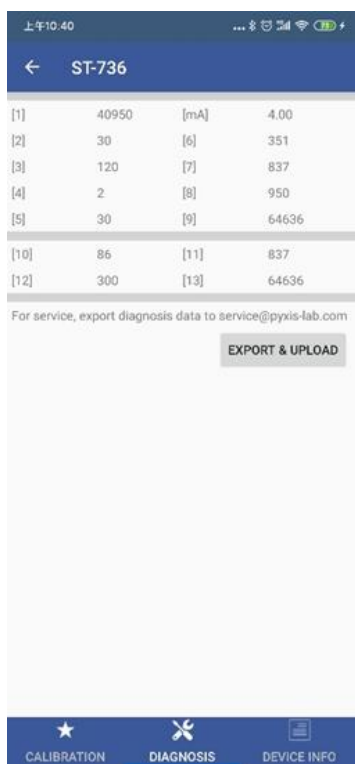

Figure 17 Select Diagnosis for Probe Data

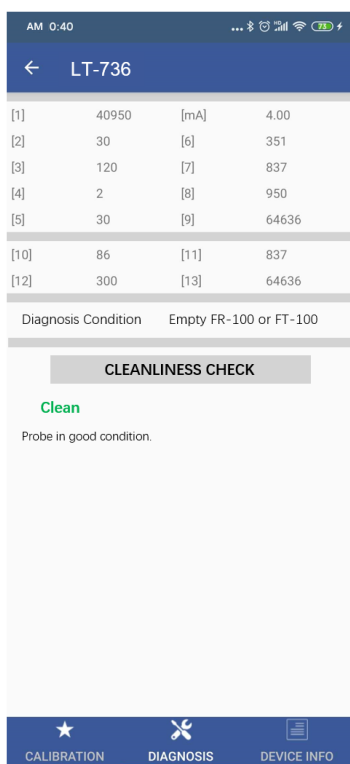

Figure 18

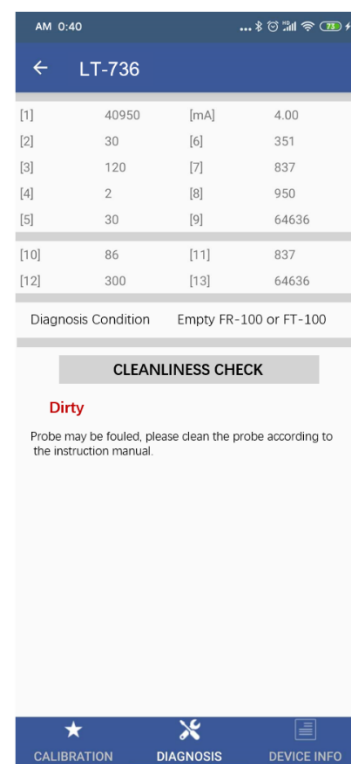

Figure 19

Export/Upload Probe Data - In this page, the raw data measured by the probe is displayed. To help troubleshooting possible issues with the probe, please save images of these data when the probe is respectively placed in a clean water (tap water or deionized water), in a turbidity standard solution, and in the sample that the probe is intended for. This data may be exported from the uPyxis APP via email to service@pyxis-lab.com for technical support. See Figure 16 Select Diagnosis for probe condition data.

Cleanliness Check - In the diagnosis page, the probe cleanliness check can be performed. Empty the FR-100 flow reservoir or FT-100 tee, Tap Cleanliness Check to carry out the check. As shown in figure 17, if the probe is clean, a green **Clean** message tab will be displayed. As shown in figure 18, If the probe is severely contaminated and scaled, a red **Dirty** message tab will be displayed. In this case, follow the steps in Section 6.0 to clean the probe.

4.2 Calibration and Diagnosis by uPyxis Desktop APP

Download and install uPyxis Desktop APP from

https://www.pyxis-lab.com/resource/software_driver/uPyxis.Setup-1.5.4.7.zip

Connect and power the LT-73X probe to a computer via the Pyxis MA-CR and MA-NEB adapter according to connection diagram below.



MA-NEB
Bluetooth Adapter

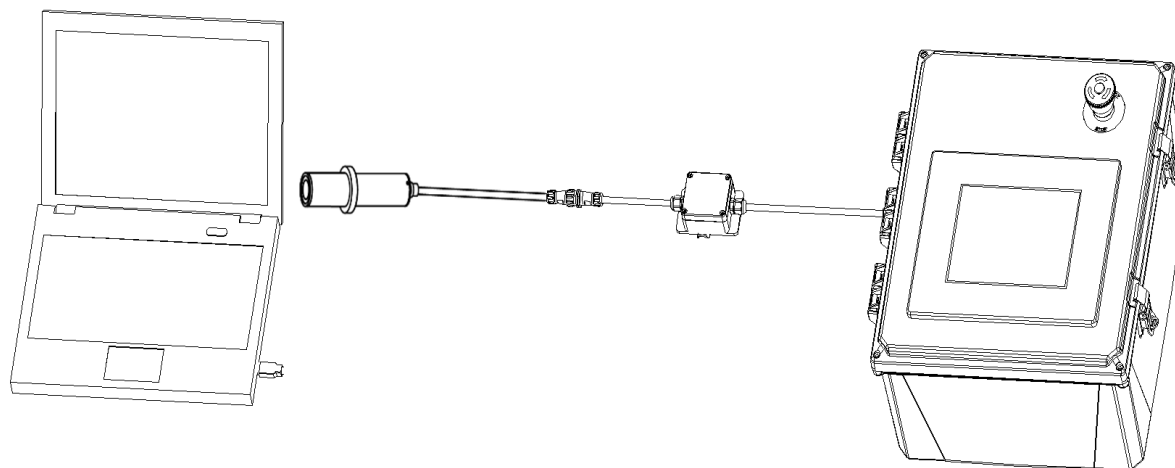

Figure 20 Connect the LT-73X to a computer via Pyxis MA-CR and MA-NEB adapter

Establish connection between uPyxis APP and the LT-73X through the following steps:

1. Open the desktop uPyxis APP.
2. Click **Device** tap to launch the connection option menu.
3. Select **Connect via USB-Bluetooth** (Figure 20).
4. Select the Comm Port to make a connection (Figure 21) (normally only one Comm port is identified by uPyxis. If more than one Comm port listed in the selection dropdown, you may try to select each one to see if a connection can be made. Alternatively, you may use the Windows Device Manager to identify the Comm Port that the Pyxis USB adapter is used.)

After the connection is established, the LT-73X probe series number and current turbidity reading of the water will be displayed on the left of the information page (Figure 22). In this page, a nickname may be assigned to the probe if desired. The probe Modbus address can be changed in this page. Click Calibration to launch the calibration page (Figure 23).

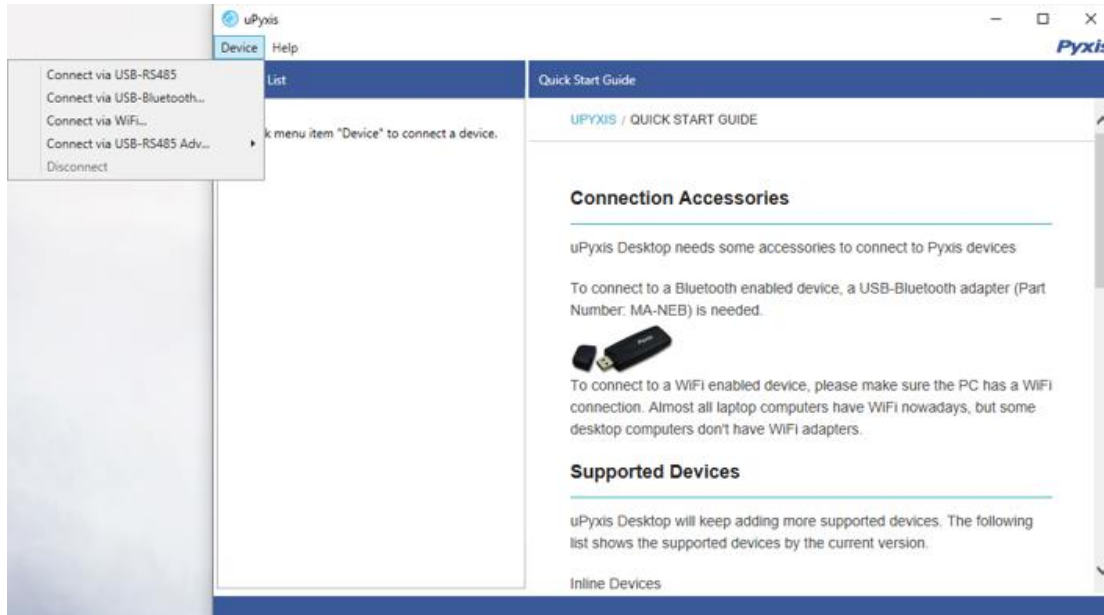

Figure 21 Connection Options

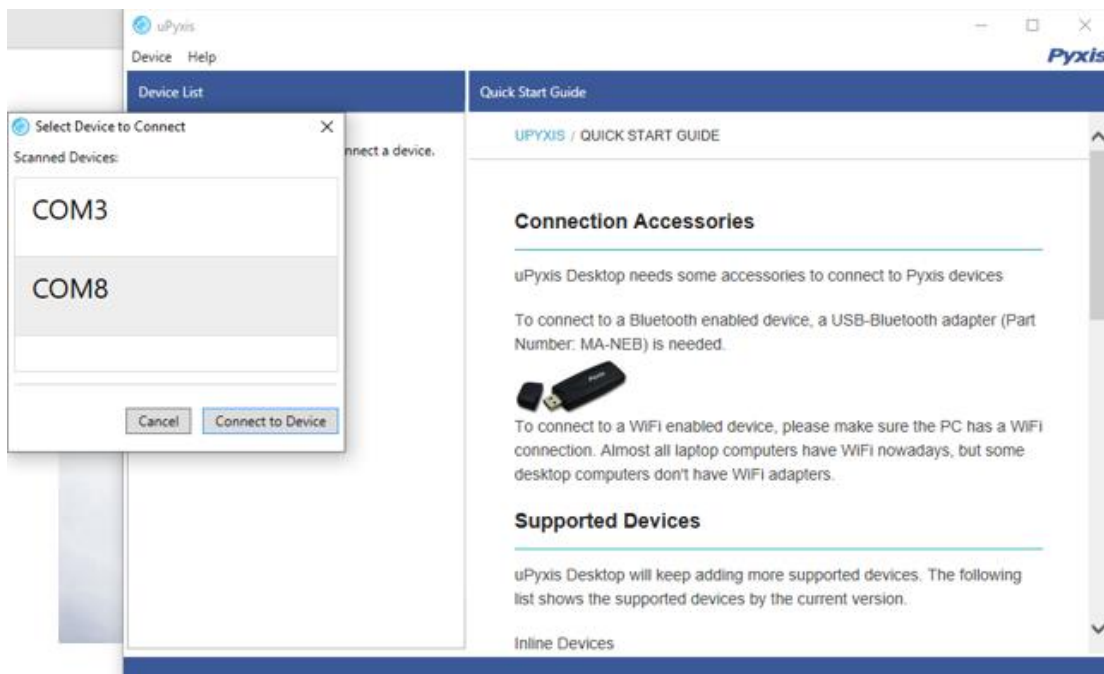

Figure 22 Select a Comm port

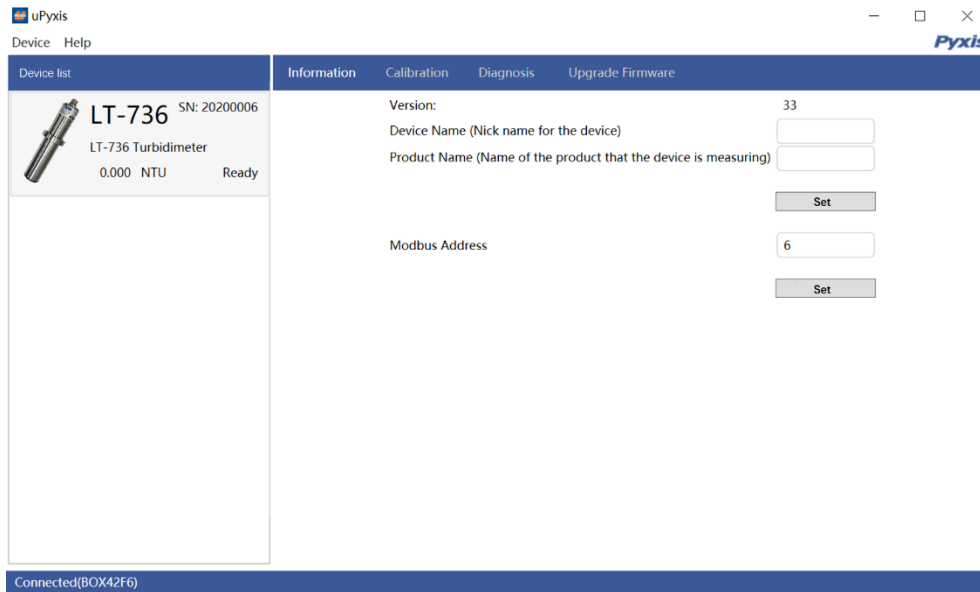

Figure 23 Connected to a LT-73X probe and information page

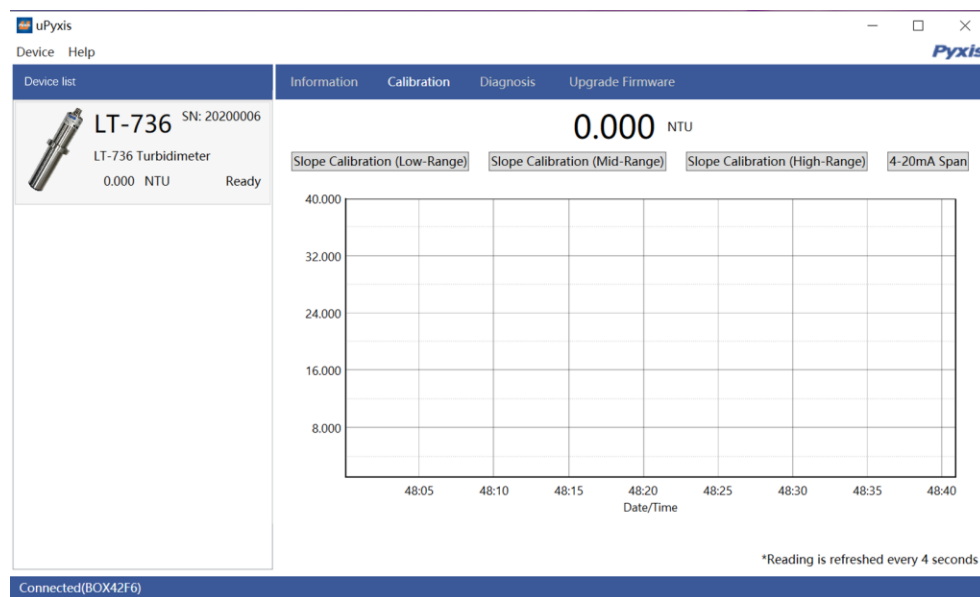

Figure 24 Calibration Page

4.2.1 Calibration

Low-Range Calibration Process - Empty the FR-100 flow reservoir or FT-100 tee, wipe the flow reservoir walls and probe surface with a dust-free cloth or dust-free paper towel, and confirm that there are no obvious contaminants on the reservoir walls and probe surface. Fill the FR-100 flow reservoir or FT-100 tee with DI (Deionized water), then use a brush or the dust-free cloth to clean the FR-100 flow reservoir or FT-100 tee walls and the probe surface, then thoroughly drain the polluted DI water. Repeat the cleaning operation three times to ensure optimum cleanliness. Then fill the FR-100 flow reservoir or FT-100 tee with bubble-free deionized water, after the displayed data is stable, click "Low Range Calibration" to perform low range calibration and enter "0"; as shown in Figure 24, if the calibration is successful, the interface will return a message "Calibration Succeeded". If the calibration has failed, the interface will return a message "Calibration Failed".

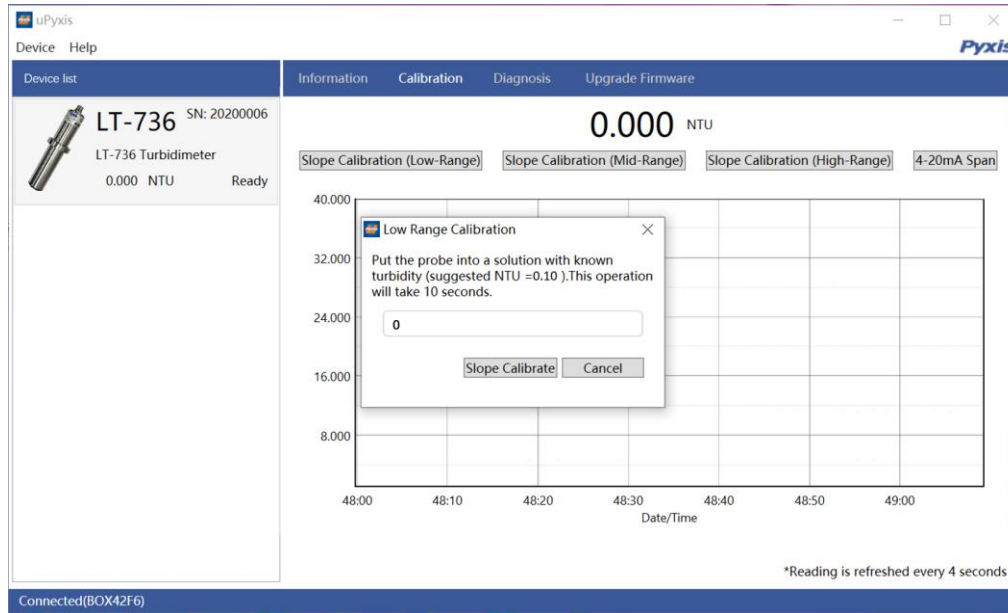

Figure 25 Low Range Calibration-DI

Optional Secondary Standard Using Reservoir or Tee - User also may use the empty FR-100 flow reservoir or FT-100 tee as the secondary standard to calibrate the turbidity probe in the Low-Range Calibration step. To do this, empty the FR-100 flow reservoir or FT-100 tee, wipe the flow reservoir walls and probe surface with a dust-free cloth or dust-free paper towel, and confirm that there are no obvious contaminants on the reservoir walls and probe surface, after the displayed data is stable, click "Low Range Calibration" to perform low range calibration and enter "0.1"; as shown in Figure 26, if the calibration is successful, the interface will return a message "Calibration Succeeded". If the calibration has failed, the interface will return a message "Calibration Failed".

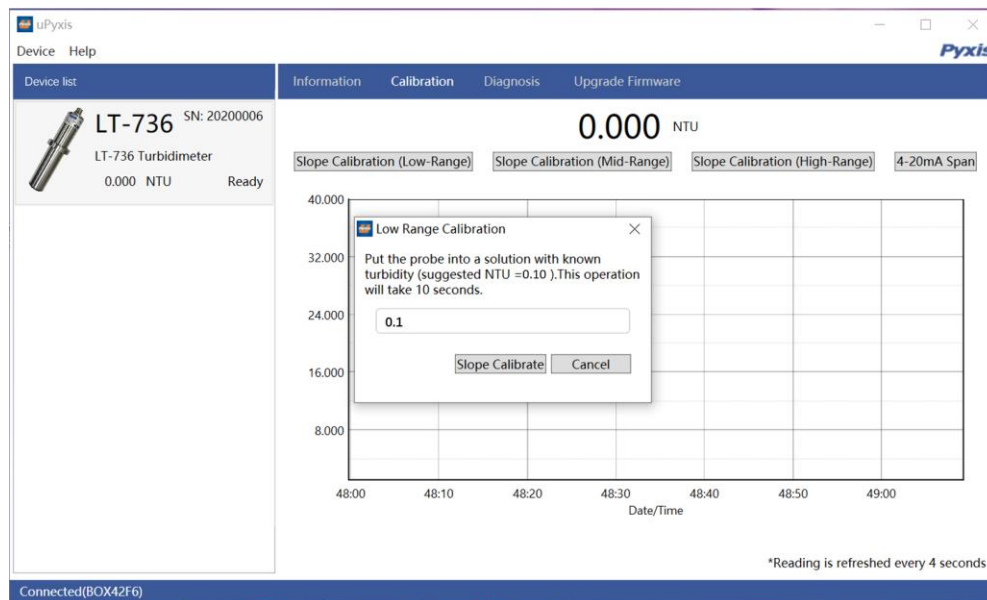

Figure 26 Low Range Calibration-Empty FR-100 or FT-100

Mid-Range Calibration Process – After conducting the Low-Range Calibration steps, refill the FR-100 flow reservoir or FT-100 tee with a known turbidity standard solution (***NOTE*** The recommended turbidity mid-range calibration turbidity standard solution for LT-736 is not less than 5NTU and not more than 10 NTU. The recommended turbidity mid-range calibration turbidity standard solution for LT-737 is not less than 0.5NTU and not more than 2 NTU), after the displayed data is stable, click "Mid-Range Calibration" to perform middle range calibration, enter the known turbidity value in the dialog window as in Figure 26, if the calibration is successful, the interface will return a message "Calibration Succeeded". If the calibration has failed, the interface will return a message "Calibration Failed".

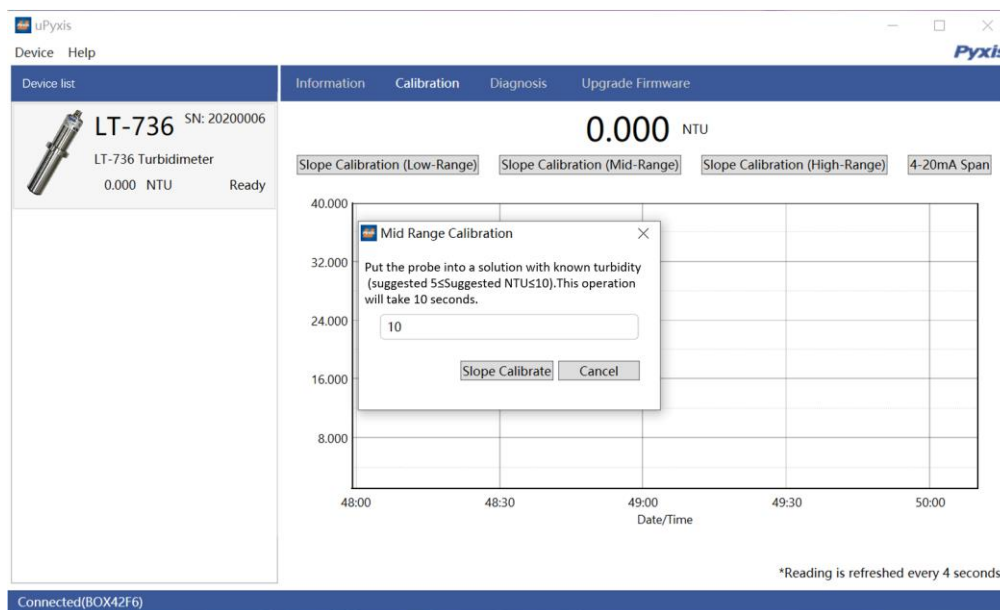

Figure 27 Mid-Range Calibration

High-Range Calibration Process - If the high range calibration is not required, the user does not need to calibrate the high range. To continue the high range calibration using the second turbidity standard solution. Discharge the first turbidity standard solution, fill the FR-100 flow reservoir or FT-100 tee with a known turbidity standard solution (***NOTE*** The recommended turbidity high-range calibration turbidity standard solution for LT-736 is not less than 500 NTU and not more than 1000 NTU. The recommended turbidity high-range calibration turbidity standard solution for LT-737 is not less than 2.0NTU and not more than 5 NTU), after the displayed data is stable, click "High-Range Calibration" to perform high range calibration, enter the turbidity value in the dialog window as in Figure 27. If the calibration is successful, the interface will return a message "Calibration Succeeded". If the calibration has failed, the interface will return a message "Calibration Failed"

Trouble Shooting Steps for Failed Calibration Messages

- The Deionized water has not been contaminated.
- The standard solution is not expired or has not been contaminated.
- The probe is clean and not contaminated with debris or other materials.
- The FR-100 flow reservoir or FT-100 tee is not blocked with debris or other materials.

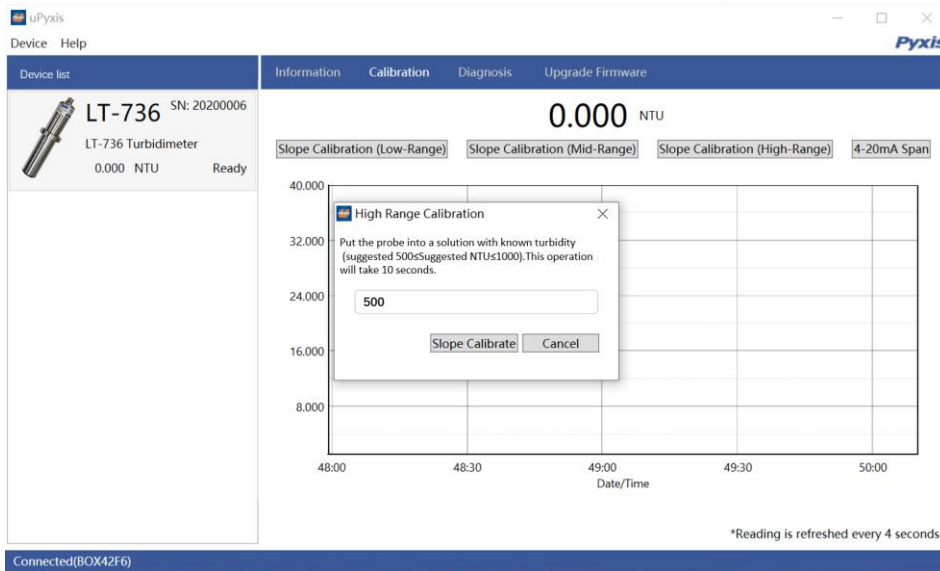

Figure 28 High-Range Calibration

4.2.2 4-20mA Span

The default 4-20mA span is 20 mA = Maximum NTU Value of Sensor Range and 4 mA = 0 NTU in water. Tap 4-20mA Span to change the turbidity in water value corresponding to the output (Figure 28). ***NOTE*** The 4-20mA Span feature allows users to REDUCE the upper 20mA output scale only. You cannot INCREASE the upper limit of the sensor.

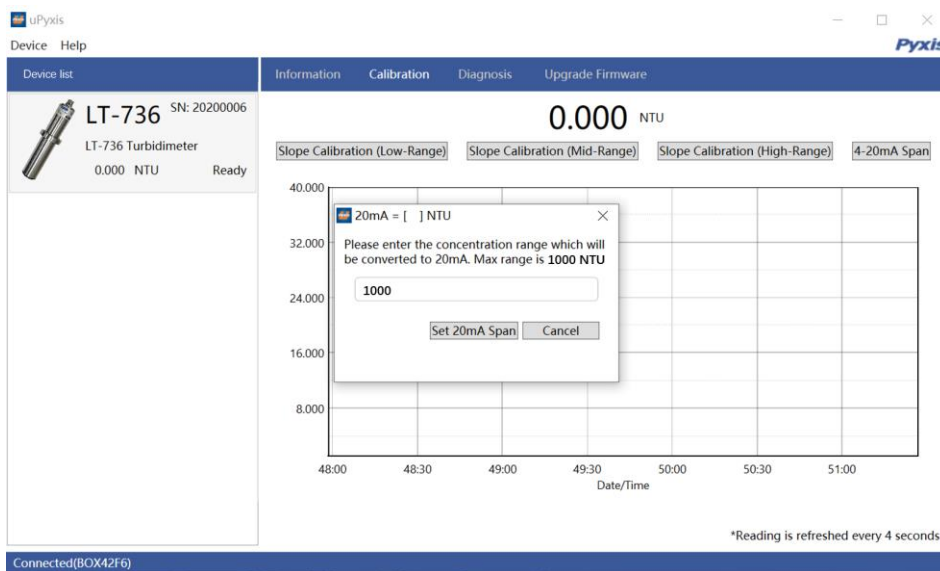

Figure 29 Set 4-20mA span

4.2.3 Diagnosis

Export/Upload Probe Data - In this page, the raw data measured by the probe is displayed. To help troubleshooting possible issues with the probe, please save images of these data when the probe is respectively placed in a clean water (tap water or deionized water), in a turbidity standard solution, and in the sample that the probe is intended for. This data may be exported from the uPyxis APP via email to service@pyxis-lab.com for technical support. See Figure 29 Select Diagnosis for probe condition data.

Cleanliness Check - In the diagnosis page, the probe cleanliness check can be performed. Empty the FR-100 flow reservoir or FT-100 tee, Tap Cleanliness Check to carry out the check. As shown in Figure 29, if the probe is clean, a green **Clean** message tab will be displayed. If the probe is severely contaminated and scaled, a red **Dirty** message tab will be displayed. In this case, follow the steps in Section 6.0 to clean the probe.

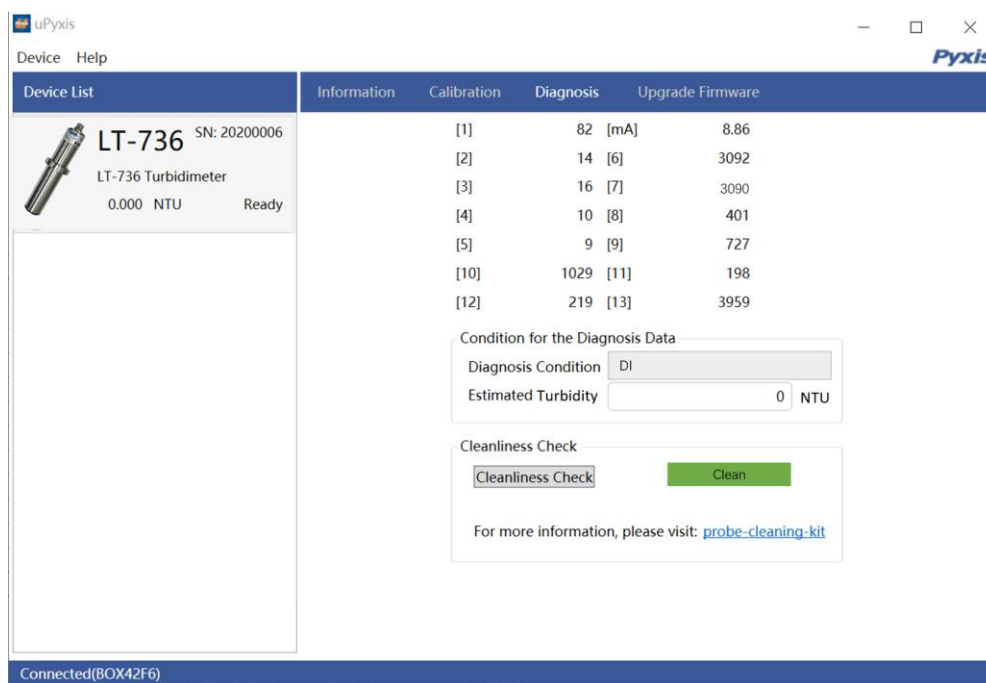

Figure 30 Select diagnosis condition and Cleanliness Calibration on the Controller

4.3 Calibration on the Controller

It is recommended that LT-73X series probes be calibrated by using uPyxis APP for Mobile or Desktop devices, as demonstrated in the sections above. Alternatively, a single point calibration can be carried on the receiving controller by adjusting the mA-to-NTU ratio. A two-point calibration could be also carried out on the controller by adjusting both the mA-to-NTU ratio and the zero-point 4-20mA current value. When conducting a two-point calibration the probes via the controller, Pyxis recommends thorough pre-cleaning of the probe be conducted prior to calibration steps. Please follow the controller manufacturer’s procedure to carry the 4-20mA calibration. With the default probe settings, the receiving controller should be set up to convert 4 mA to 0 NTU and 20 mA to maximum range of the probe in use.

If the user implements a 4-20mA SPAN adjustment of the Pyxis probe via uPyxis, the new span (4-20mA output scale) must be correspondingly configured in the receiving controller for proper results.

5 Modbus RTU

The LT-73X probe is configured as a Modbus slave device. In addition to the NTU turbidity in water value, many operational parameters, including warning and error messages, are available via a Modbus RTU connection.

Contact Pyxis Lab Customer Service (service@pyxis-lab.com) for more information.

6 Probe Cleaning and Maintenance

The LT-73X probe is designed to provide reliable and continuous ultra-low turbidity readings. Although the optics are compensated for the effects of moderate fouling, heavy fouling will prevent the light from reaching the sensor and can impact the probe accuracy, depending on application conditions.

The LT-73X probe is designed to be easily removed, inspected, and cleaned if required.

The need to clean the LT-73X probe can be determined by the Cleanliness Check function using uPyxis APP as described in the above section.

6.1 Cleaning Procedure

Aged heavy deposition, especially iron and calcium based deposits, can be removed using the Pyxis Probe Cleaning Solution Kit available from Pyxis online Estore/Catalog <https://pyxis-lab.com/product-category/accessories/page/2/>

Refer to Section 4.0 to conduct the cleanliness check on the probe prior to cleaning. Then remove the probe and soak the lower half in 100 mL of Pyxis Probe Cleaning Solution for 15 minutes. After soaking, gently wipe with a dust-free cloth or paper towel then rinse the LT-73X probe with distilled water. After conducting the cleaning process, users may re-check the probe diagnostics using the “Cleanliness Check” function in the uPyxis APP. If properly cleaned, the uPyxis APP will show a green **CLEAN** message. If the surface is not entirely clean, the uPyxis APP will show a red **DIRTY** message. In this case, continue to soak the LT-73X probe for an additional 15 minutes then repeat until clean.



Figure 31 Pyxis Cleaning Solution Kit

6.2 Other Common Troubleshooting Issues

If the LT-73X probe output signal is not stable and fluctuates significantly, make an additional solution ground connection – connect the clear solution ground wire to a conductor that contacts the sample water electrically such as a brass pipe adjacent to the LT-73X / FR-100 flow reservoir or FT-100 tee.

Contact us

Contact us if you have questions about the use or maintenance of the LT-73Xprobe:

Pyxis Lab, Inc.

1729 Majestic Dr. Suite 5

Lafayette, CO 80026 USA

1-866-203-8397

www.pyxis-lab.com

service@pyxis-lab.com